

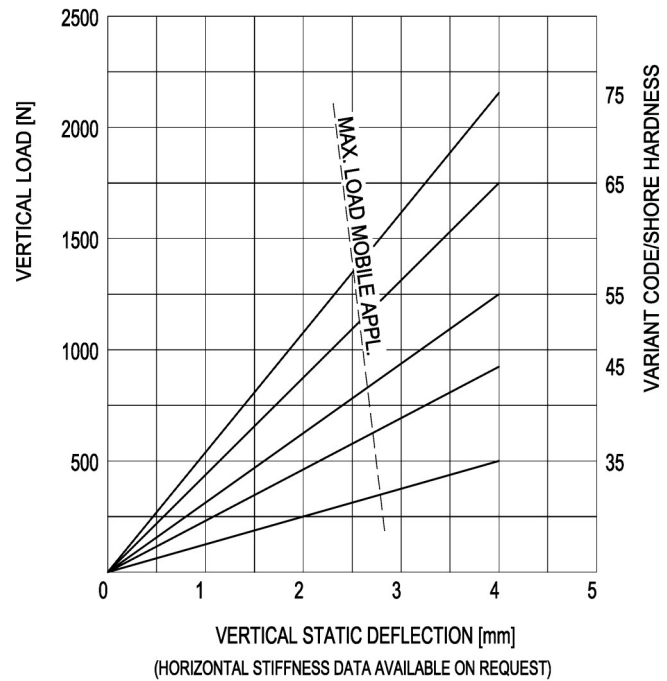

CM-Mounting
type 10-CM-215-A
Max. 215 kg - 4 mm - 8 Hz

CM-Mountings are mostly used for mobile applications. These compact anti-vibration mountings are easily integrated in the supporting structure and offer a high level of vibration insulation. Rebound control-washers limit excessive movement under shock loads. CM-Mountings are available in several rubber mixes to accommodate a large load range.

Applications: marine engines and generator sets, pump units, vehicle cabins, compressor sets, etc.

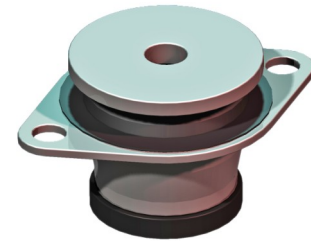

CROSS-SECTION

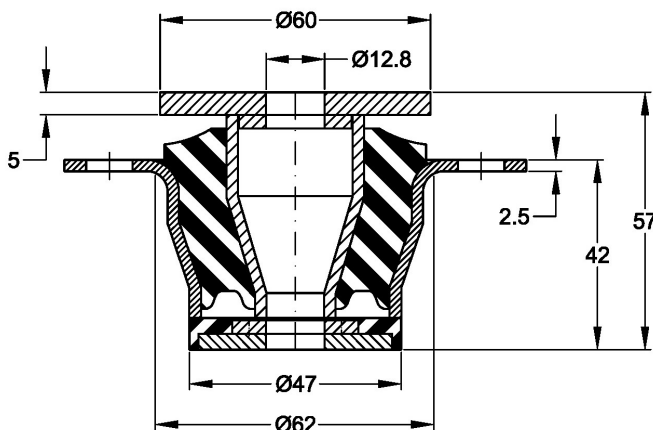

TOPVIEW

