

Hanger Element

type 20-HA-300-A

Max. 300 kg - 5 mm - 7 Hz

HA-type Hanger-Elements are typically used to isolate suspended fans, duct-work, fan-cool units, packaged air-conditioners, pipes, etc. They are also very effective for the support of suspended ceilings where acoustical isolation is required. The static deflection ranges up to 5 mm. and features protection against complete loss of support in the event of mechanical or fire damage. Customers are recommended to contact our application engineers for further technical information on products and applications.

Applications: hanger-elements for piping, acoustic ceilings, fans, air-conditioning units, sensitive equipment, etc.

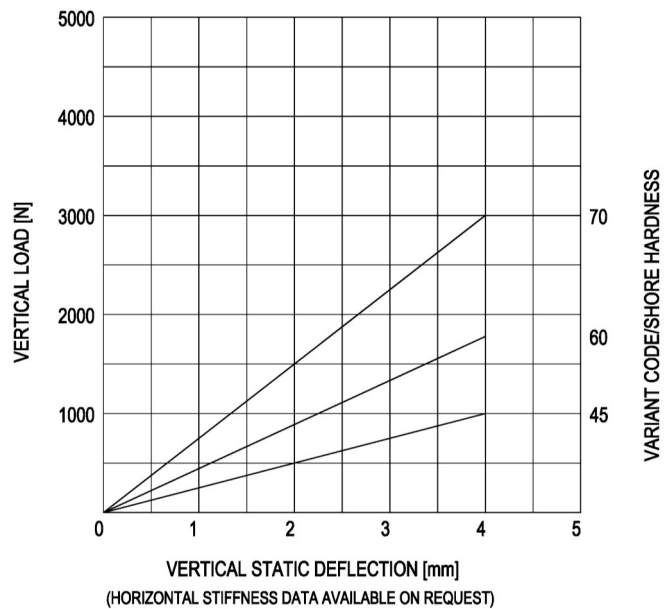
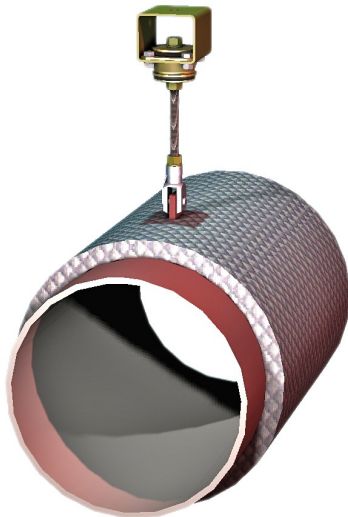
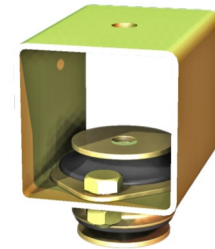

CROSS-SECTION

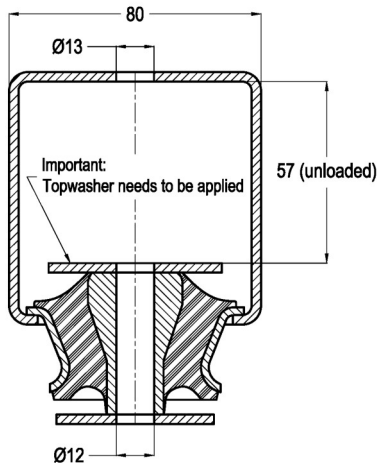

SIDEVIEW

